

**FPU® SYSTEMS OPERATION MANUAL
(INCLUDING REPAIR PARTS & SPECIAL TOOL LIST)
MODELS FPU-8-4/BOH-CARGO-12-3 & FPU-20-3
BOH FPU Field Pack-up Units**

Appendix C

BULK STORAGE AIDS (REAR) REMOVE/INSTALL PROCEDURES

This page was intentionally left blank

REMOVE/INSTALL PROCEDURES
Bulk Storage Aids (Rear)
(FPU 8-4 and 8-ft Compartment of FPU 20-3 Containers)



Bulk Storage Aids (Rear)

BOH FPU® Systems
BOH ENVIRONMENTAL LLC
14520 Avion Parkway, Suite 220
Chantilly, VA 20151
POC Jim Stokes (703) 449-6020
<http://www.bohfpusystems.com>

Parts List:

DESCRIPTION	QUANTITY	DESCRIPTION	QUANTITY
UPRIGHTS	2	FLAT WASHER 1/2" ZP HEAVY	8
FLOOR PLATES	4	LOCK WASHER 1/2"	32
TOP COLLARS	8	CARRIAGE BOLT 1/4" X 3/4"	40
PALLET LEDGE LEFT	2	FLAT WASHER 1/4"	40
PALLET LEDGE RIGHT	2	WHIZ NUT 1/4"	40
SHOULDER BOLT	4	UNISTRUT NUT	24
EXTENSION SPRING	4	BOLT 3/8" X 3-1/2"	8
CLEVIS PINS	4	FLAT WASHER 3/8" ZP	20
1/2" NYLON FLAT WASHER	4	NYLON NUT 3/8"	12
1" X 5/16" BUTTONHEAD SCREWS	16	2" RATCHETS	8
LOCK WASHER 5/16"	16	67" PALLETS	2
BOLT 1/2" X 1"	24	67" RACK SUPPORT	4
BOLT 1/2" X 1-1/2"	8	NET	1
		WASHER-FLAT 1/2" SAE ZP GR8	16

Required Tools:

- 7/8" combination wrench
- 7/8" deep well socket
- 1/2" drive flex head wrench
- 3/16-inch hex head driver socket
- 3/8-inch ratchet with extension
- 7/16-inch socket and ratchet with extension
- 2 X 4 soft wooden block
- 3/4-inch socket with ratchet
- 9/16-inch socket
- 9/16-inch box wrench

REMOVAL PROCEDURES

Pallets

1. Loosen jam nuts using 7/8-inch combination wrench.

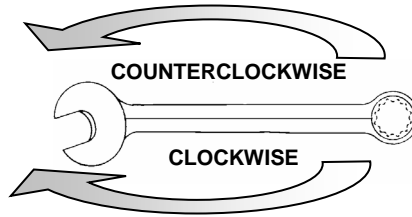

NOTE

All hardware, bolts, jam nuts, and screws are loosened with a counter clockwise rotation. All hardware, bolts, jam nuts, and screws are tightened with a clockwise rotation.

2. Completely retract lock rods using 7/8-inch deep well socket and 1/2-inch drive flex head wrench. Turn lock rods counterclockwise fully until retracted. The rod will bottom out when fully retracted.

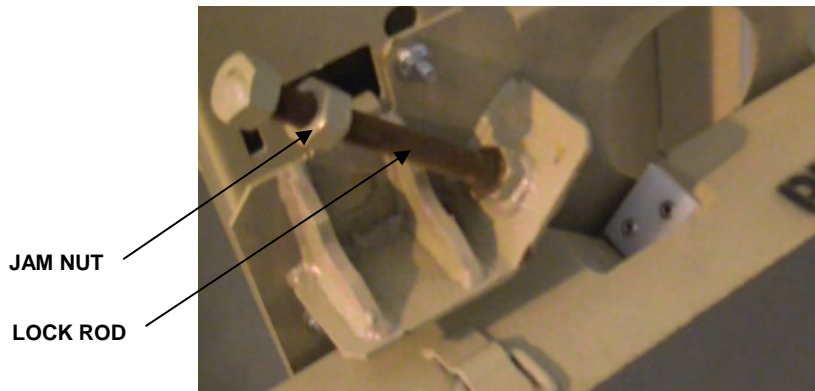

3. If pallets are empty, they can be removed by hand with two people. Skip to step 13. If pallets are loaded with material, continue with step 4.



4. Adjust forklift tines to match fork pockets of pallet to be removed.
5. Using the Ground Guide, insert tines into pallet until contact with pallet stops is made.

6. Using one of the 2-inch ratchet straps provided, attach one hook to left front pallet D-ring. Straps are used to overcome the rear cam lock tension.
7. Feed strap through the forklift bridge to opposite side and attach to right front pallet D-ring. Tighten ratchet strap to remove any slack.
8. Raise the forks approximately 1-inch.
9. Back out slowly approximately 12-inches to allow pallet to clear rear cam lock.
10. Tilt forks back to obtain approximately 1-inch of clearance between the pallet and pallet ledge.
11. Continue backing out until clear. Once clear of container, position pallet to desired location and lower to the ground.
12. Disconnect ratchet straps from pallet D-rings and remove from Forklift Bridge.

Pallet Ledge Stabilizer

13. Remove front and rear pallet ledge stabilizer by turning the eight Button Head Bolts counterclockwise on each side of the stabilizer using 3/16-inch hex head driver socket and 3/8-inch ratchet with extension.

NOTE

The operator must crawl into the container to remove the rear bolts.

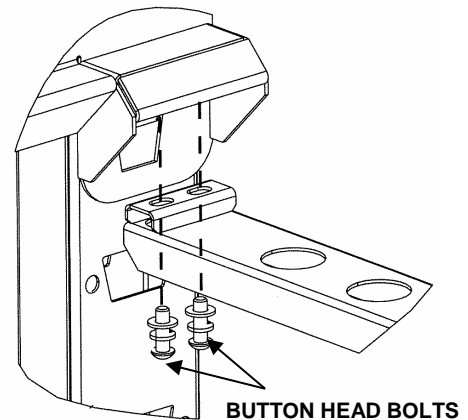
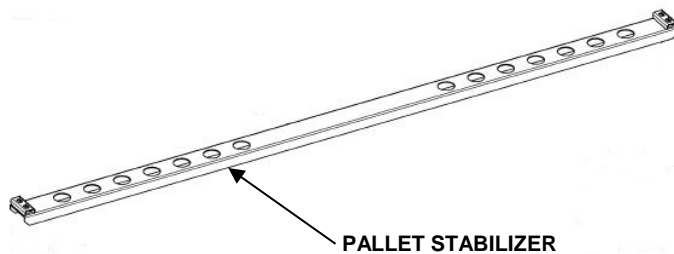

Pallet Ledges

WARNING

Personnel may decide to leave the ledges connected to the vertical rack frame upon re-installation into the new container. However, personnel shall proceed at their own risk as the additional weight associated with this configuration may result in a more cumbersome re-installation.

14. Loosen, but do not remove, the ten carriage bolt nuts (5 each end of ledge) using 7/16 - inch socket and ratchet with extension from the two pallet ledges on the vertical rack frame.

WARNING



Never work underneath loaded pallets. Failure to comply could cause serious injury or death.

CAUTION

If a bolt is lost or damaged beyond use, obtain a replacement. Do not install with less than the proper number of bolts or damage to equipment may occur.

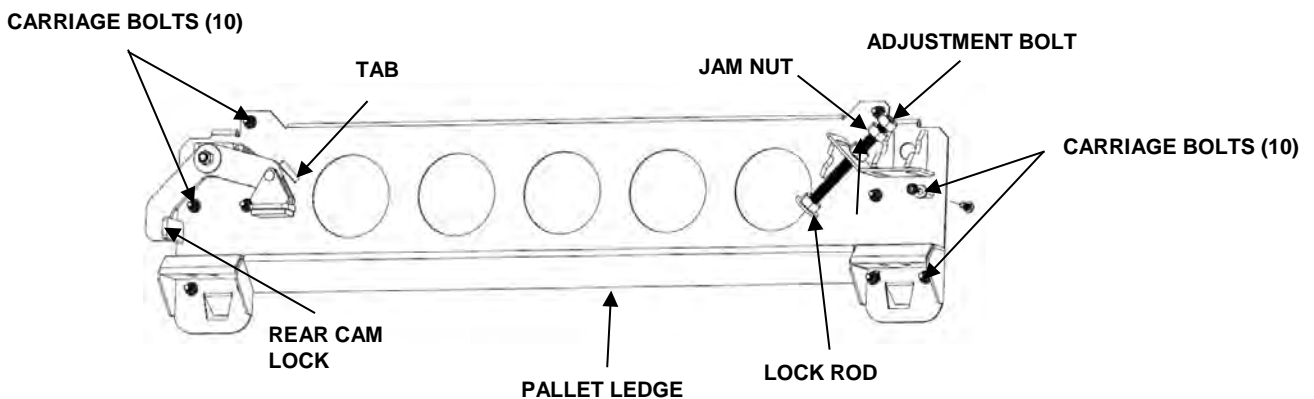

15. Pallet ledges are retained on the vertical rack frame by ten ¼-inch carriage bolts and four bayonet tabs protruding into the windows of the vertical rack frame. This requires the ledge to be loosened from the vertical rack frame. While one person securely holds the pallet ledge, the second person applies an upward force by tapping the underside of the ledge at the attached point with a 2 X 4 soft wooden block or similar material.



16. Remove the pallet ledge from the vertical rack frame.

17. Repeat steps 13 through 16 for remaining pallet ledges and pallet ledge stabilizers.

Floor Nets

18. Unclip and remove floor net.

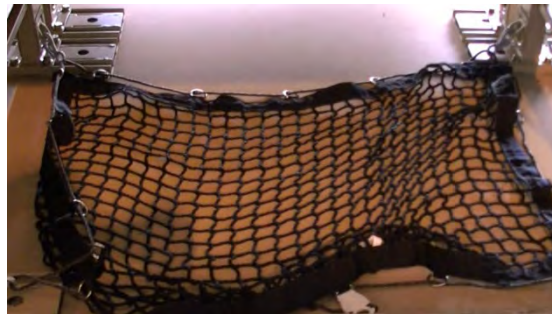

Vertical Rack Frame

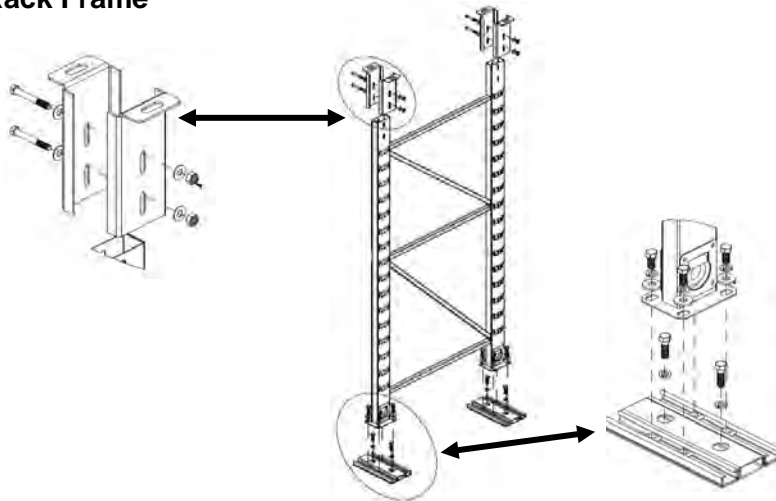

19. With someone holding the vertical rack frame, remove the 1/2-inch hex head bolts and washers from the top (2) and bottom (4) mounting plates using a 3/4-inch socket with ratchet.
20. Loosen, but do not remove, the bolts on the upper sleeves. Slide the upper sleeves down and remove vertical rack frame.
21. Remove the bottom base frame bolts and washers (2) from the base and remove base with unistrut channel nuts inside base channels.

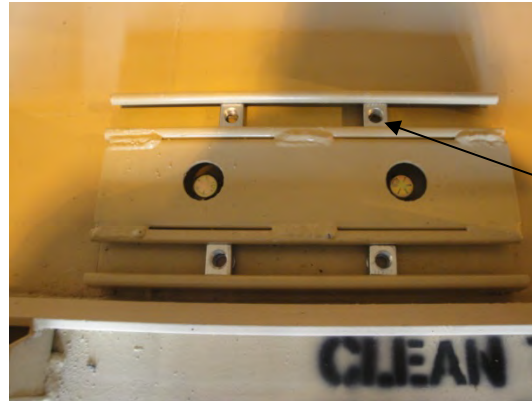

UNISTRUT NUTS

22. Remove unistrut channel nuts from mounting channels in ceiling.



UNISTRUT NUTS

23. Repeat steps 19 through 22 for remaining vertical rack frames.

END OF BULK STORAGE AIDS (REAR) REMOVAL PROCEDURES

INSTALLATION PROCEDURES

Vertical Rack Frame (part 1)

1. Place 4 mounting base plates in the 4 designated pairs of holes in the floor and secure each plate with (2) ½-inch lock washer and (2) 1 ½-inch hex bolts. Apply Locktite 262 to bolt threads and tighten bolts using a ¾-inch socket with ratchet.

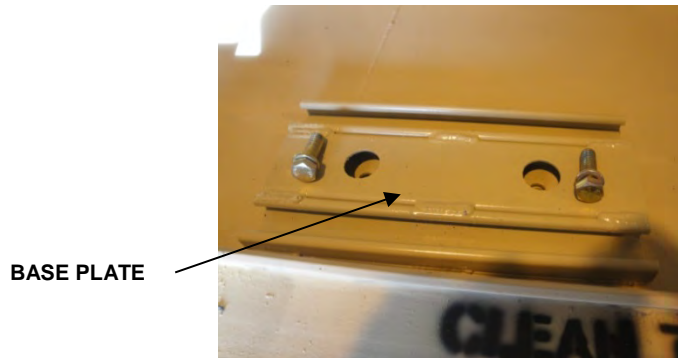

2. Install (4) unistrut channel nuts to each base plate and (2) unistrut channel nuts to the mounting channel in ceiling at approximately the locations described in steps 6 through 7 below.

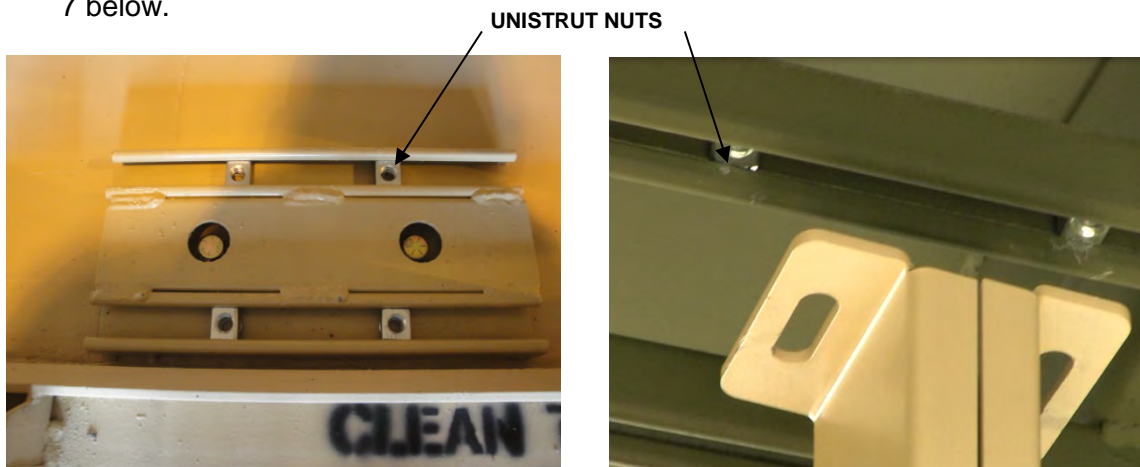

3. Install (2) vertical rack frames to base plates with (8) ½" lock washers, (8) ½" (zp gr8) flat washers and (8) 1-inch bolts. Apply Locktite 262 to bolt threads and hand tighten only.
4. Attach (2) upper sleeve assemblies to each upper vertical rack. Secure sleeves to rack with (4) 3 ½-inch bolts, (8) 3/8-inch (zp) flat washers and (4) 3/8-inch nuts. Apply Locktite 262 to bolt threads and hand tighten only.

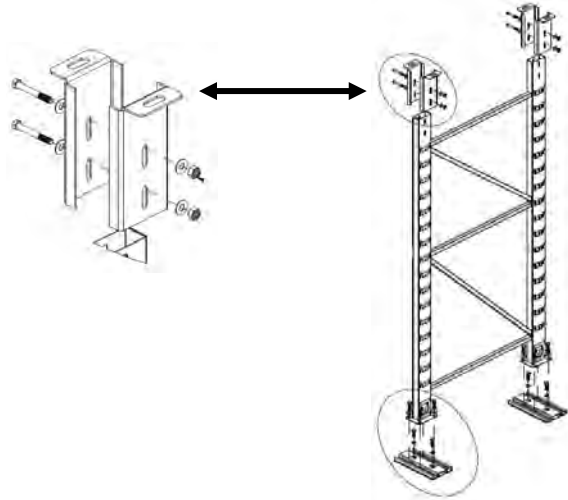

5. Secure upper sleeves to ceiling mount using (4) 1-inch bolts, (4) ½-inch lock washers, and (4) ½-inch (zp heavy) flat washers. Apply Locktite 262 to bolt threads and hand tighten only.



6. Install the **first** vertical rack frame from the side closest to the container access steps (opposite the FPU 20-3 bail bar end). The frame upright should measure approximately **8 1/8-inch** from the inside of the container wall to the outside of the upright and sit flush against the welded brace. Once the correct measurement is verified at all four points on the vertical rack frame, tighten the bolts on the top and bottom mounting plates using a ¾-inch socket and ratchet.



NOTE

Tighten the bolts on the upper sleeves using a 9/16-inch socket and 9/16-inch box wrench before tightening the bolts on the ceiling mount.

7. Install the **second** vertical rack following steps 3 through 5 above. Measure **67 inches** from the inside of the first rack to the inside of the second rack. Once the correct measurement is verified at all four points on the vertical rack frame, tighten the bolts on the top and bottom mounting plates using a 3/4-inch socket and ratchet.

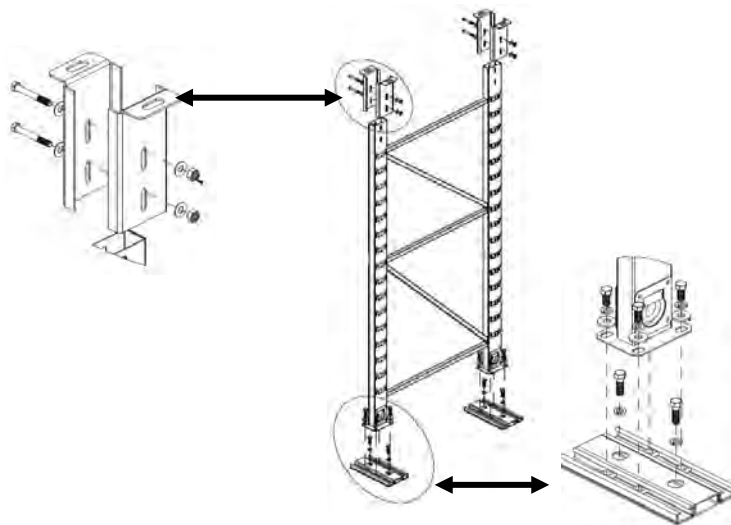

Pallet Ledges

8. Install (10) ¼-inch carriage bolts with ¼-inch flat washers and nuts to each pallet ledge (5) in the front and (5) in the back of each ledge. These bolts should be loose when installing on pallet ledges.

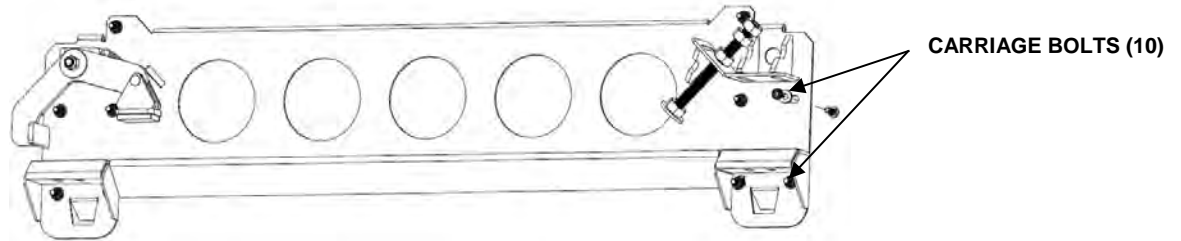

9. Place the pallet ledges in their desired positions by inserting the bayonet tabs into the vertical rack frame windows while aligning the ten carriage bolts into their appropriate slots.

NOTE

Ensure the pallet ledges are at the same height in the vertical rack frame and ensure bayonet tabs have engaged the vertical rack frame windows before tapping into place.

10. Slots are tear drop to retain the head of the ¼-inch carriage bolts. Tap down on the ledge with a 2 X 4 soft wooden block or similar material. Ensure the carriage bolts drop completely down in the slots.

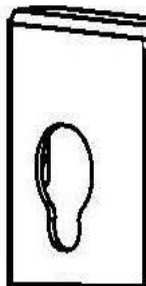

TEAR DROP SLOT



11. Apply Loctite 262 to the ten ¼-inch nuts on the carriage bolts for each pallet ledge.
12. Tighten the pallet ledges to rack frame by tightening the ten carriage bolt nuts using a 7/16-inch socket with ratchet and extension.
13. Repeat steps 8 through 12 for all remaining pallet ledges.

Pallet Ledge Stabilizer

14. Use the pallet ledge stabilizer to obtain proper spacing by attaching, but not tightening, the stabilizer beneath the pallet ledge at the vertical rack attachment point.



15. Install rear pallet ledge stabilizer with four Button Head Bolts with 5/16-inch lock washers using 3/16-inch hex driver socket and 3/8-inch ratchet with extension from the two positions of each pallet ledge. There are four bolts located at each vertical rack frame.

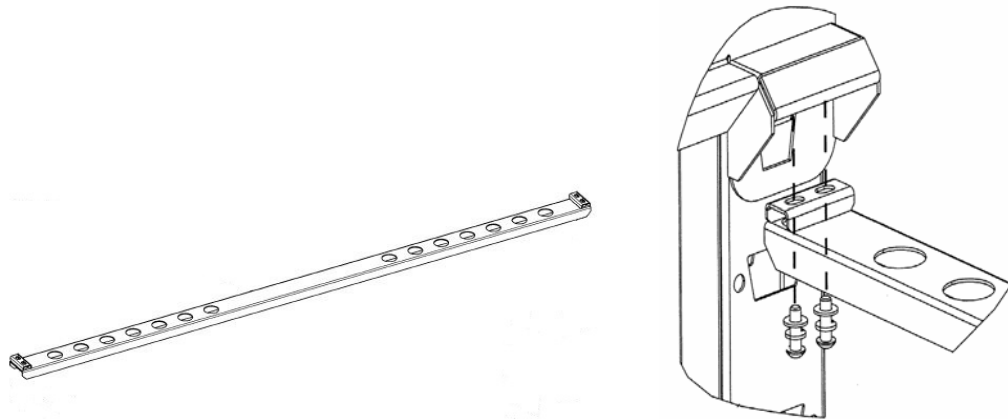

16. Install front pallet ledge stabilizer with the four Button Head Bolts with 5/16-inch lock washers using 3/16-inch hex driver socket and 3/8-inch ratchet with extension from the two positions of each pallet ledge. There are four bolts located at each vertical rack frame.
17. Repeat steps 14 through 16 for all remaining pallet ledge stabilizers.
18. Tighten pallet ledge stabilizers once they are all positioned.

Vertical Rack Frame (part 2)

19. Ensure all bolts on the rack upper attachment and vertical rack frame base are tight using a $\frac{3}{4}$ -inch socket with ratchet.

Pallets

20. Ensure all front lock rods on pallet ledges have been completely retracted prior to inserting the pallets.



21. If pallets are empty, position the pallets on the pallet ledge by hand with two people. Then skip to step 26. If loaded with material, proceed to step 22.

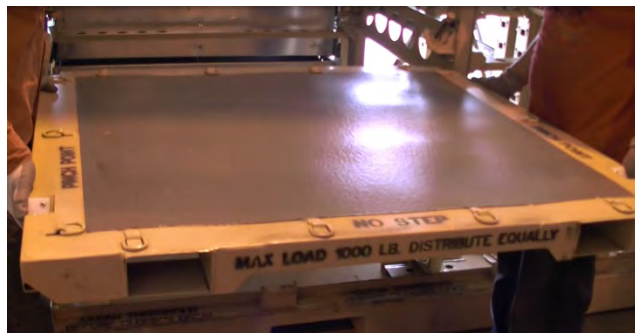

CAUTION

The following process will require a forklift operator and a ground guide.

22. Adjust forklift tines to match fork pockets of pallet to be installed.

NOTE

Pallets are designed with a forklift tine stop to ensure proper distance is maintained between the forklift bridge and the FPU container. It also assists in inserting the pallet to the rear locked position.

23. Using the ground guide, align pallet to the pallet ledge opening.
24. Insert the pallet approximately 12 inches into the pallet ledge, lower the pallet and allow it to slide along the pallet ledge into the lock position.

25. Retract forklift.

26. Tighten the lock rods evenly using 7/8-inch deep well socket and ratchet (or ½-inch drive flex head wrench) to 120 lb.-in. (105 psi) to secure the front of the pallets.

NOTE

Alternate tightening sequence left to right to ensure pallet is properly seated on the pallet ledge under the locking cam located at the rear of the pallet.

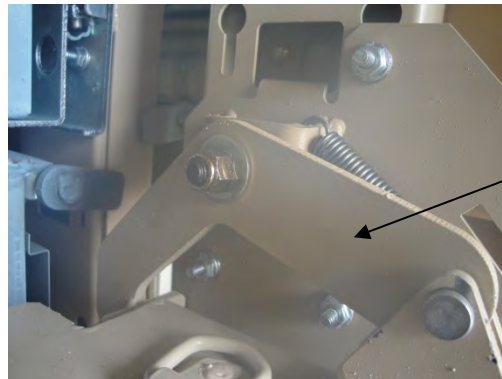

CAM LOCK

27. Tighten jam nut using 7/8-inch combination wrench to hold lock rod in the closed position.

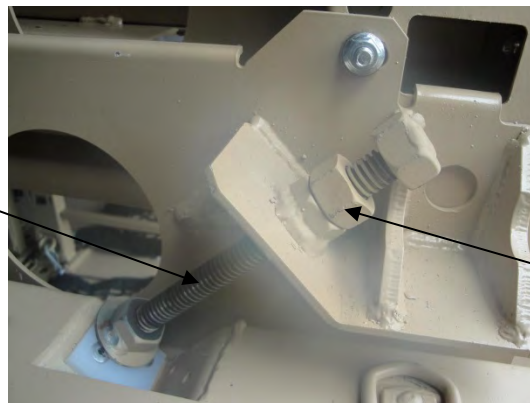

LOCK ROD

JAM NUT

28. Repeat steps 21 through 27 until all pallets have been installed in their appropriate positions.



29. Install and clip floor cargo nets in their appropriate positions.

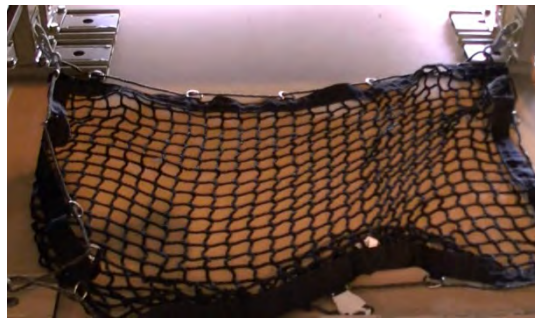

END BULK STORAGE AID (REAR) INSTALLATION PROCEDURES